

The all new PACCAR MX 13 complete line of gaskets, gasket kits and seals.

Now available!



Website



Facebook



YouTube



Das Original

As an automotive supplier, ElringKlinger has become a trusted partner to its customers – with a firm commitment to shaping the future of mobility. Celebrating 140 years of engine gasket excellence in 2019. All efforts to stay ahead are supported by a dedicated workforce of more than 10,000 employees at 45 ElringKlinger group locations around the globe.

Latest emission standards which went into force in North America in 2010 as EPA 10 changed the design of heavy duty engines dramatically. Diesel engine manufactures were forced to cope with that.

The Paccar MX 13 engine features an extremely high level of injection pressure of up to 2000 bar using the common rail technology. Increased combustion pressure with a ratio of 16,5 to 1, resulting in higher burning temperatures. Consequently meaning a gain in the sealing gap oscillations between cylinder block and cylinder head. In addition to that, engine block and cylinder head are casted in a lighter so called Compacted Graphite Iron, reducing the applicable cylinder head bolt force remarkably.

Taking all of that into account, there was a need to come up with a new design for the cylinder head gasket. Result is a technology unparalleled to the engine gasket world.

The cylinder head gasket is designed as metal elastomer gasket, meaning the sealing of engine oil and coolant is done via rubber injection molded sealing lips directly on a metal carrier. There are such two central carriers each spanning for three cylinders. Sealing of the combustion chambers are executed with an embossed bead on the carrier plates and an additional stainless steel fire ring to cope with the high compression ratio as described.

Due to the overall length of the gasket, ElringKlinger had to invent a design which can be best described as a puzzle and which is unique to the gasket industry. Eight different gasket elements are combined to form the entire gasket, including a lateral metal layer to support the integral sealing.

Besides the cylinder head gaskets, Elring is also offering gasket kits and individual gaskets such as intake or exhaust gaskets. But also valve cover and oil pan gaskets.

More details about the other heavy duty diesel engines can be found on www.elring.com where exploded drawings are available for an easy look up for parts and free download.

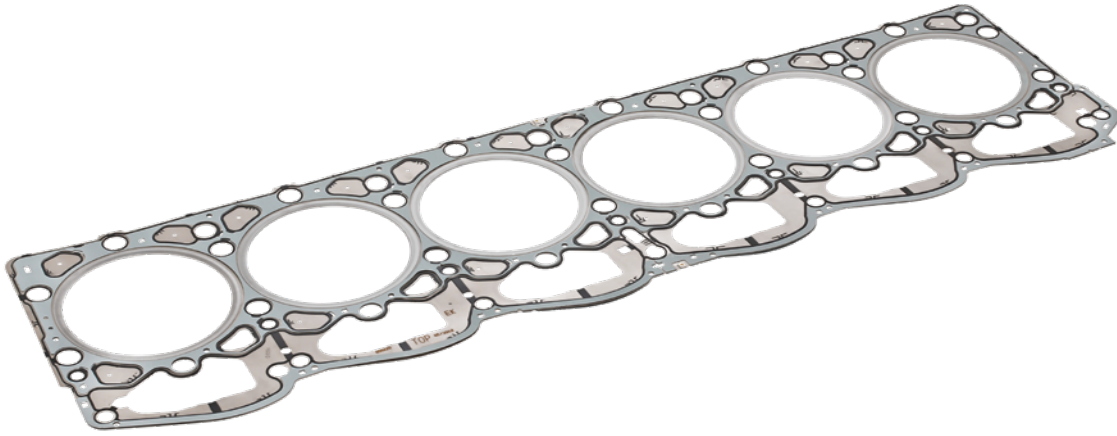

: 575.042 // OE # 1932 890

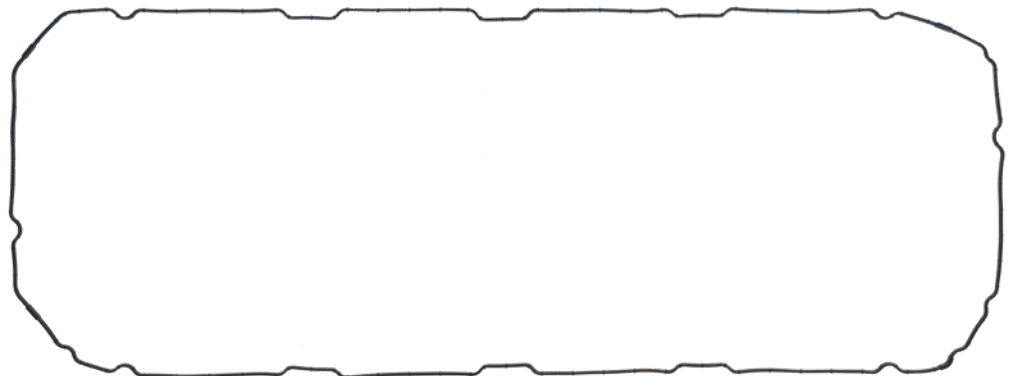



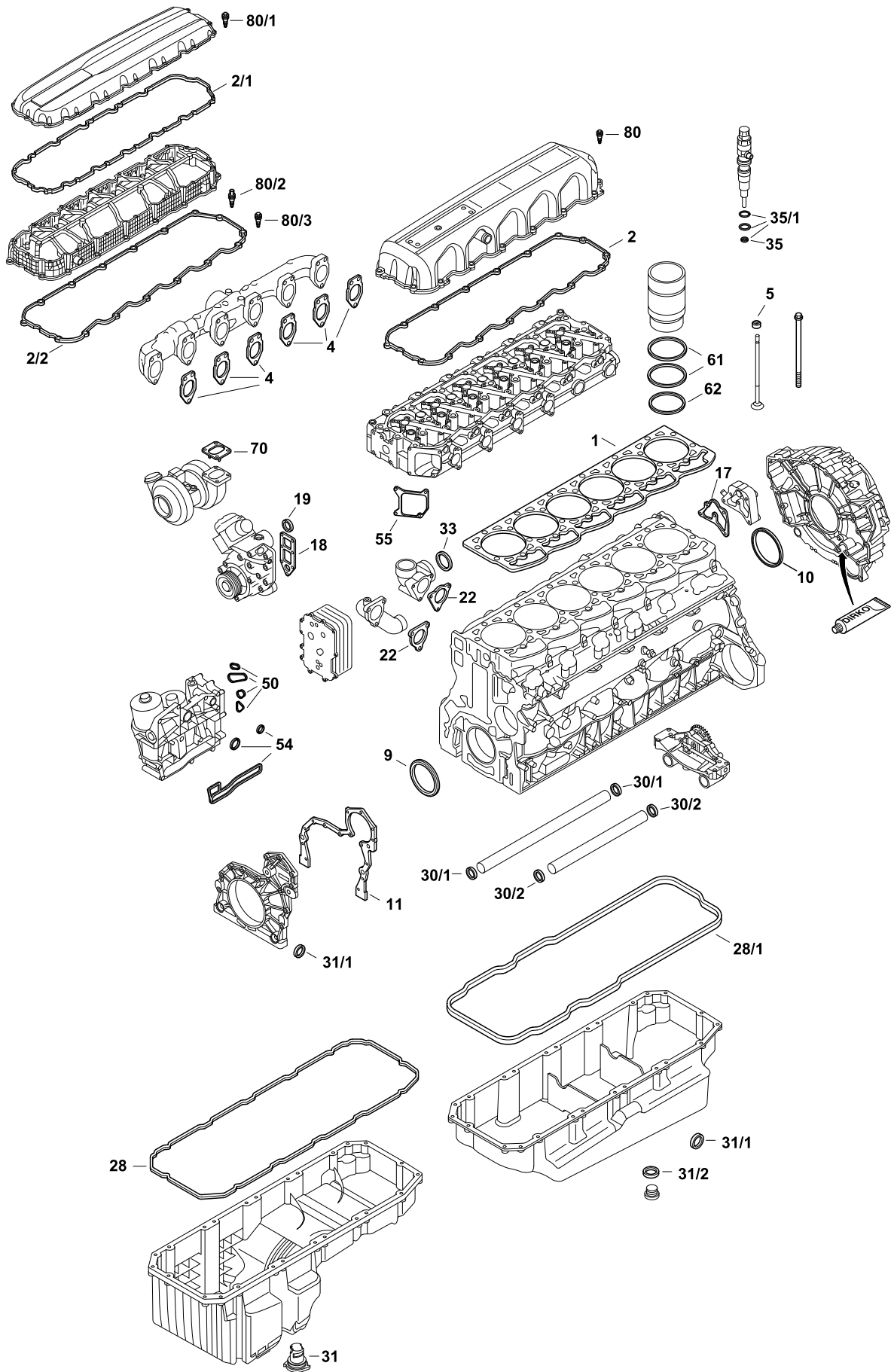

: 377.230 // OE # 2111 441

Oil pan gasket

MX 13 – EPA 10



							
	478.880	1x	2005 461	-	-	-	-
	478.890	1x	2036 375	-	-	-	-
Kit	308.930	6x	-	Cylinder liner rings	Pos . 61 + 62	-	-
	259.560	1x	-	-	26x 1822 166, Kit	-	-
	259.561	1x	-	-	26x 1822 166 7x 1822 941, Kit	-	-
1	575.042	1x	1874 963	-	-	-	-
2	246.160	1x	1924 761	VMQ		-	-
2/1	440.220	1x	2105 834	AEM	 	-	-
2/2	440.230	1x	2105 835	AEM	 	-	-
4	478.670	6x	2106 219	-	-	-	-
5	242.510	24x	1813 133	10x12,8/16,5x10,9 FPM	-	-	-
9	278.000	1x	1876 189	134x161x16 ASW RD PTFE/ACM	-	-	-
10	278.020	1x	1876 190	166x191x16 ASW LD PTFE/ACM	-	-	-
11	439.570	1x	1781 714	-	-	-	-
17		1x	1786 142	-	-	-	-
18	801.610	1x	1880 063	Metal	-	-	-
19	375.710	1x	1670 331	51x5 FPM RD	-	-	-
22		2x	1885 500	-	-	-	-
28	377.230	1x	1853 603	AEM		-	-
28/1	246.170	1x	1925 946	AEM		-	-
30/1	262.610	2x	1608 393	Ø 32 mm	-	-	-
30/2	262.620	2x	1608 394	Ø 38 mm	-	-	-
31	233.451	1x	1982 821	-		-	-
31/1	107.239	1x	0331 326	10x13,5x1 CU A	-	-	-
31/2	133.400	1x	0119 135	26x32x2 CU A	-	-	-
35	475.290	6x	2127 551	7x16,5x2 FE A	-	-	-
35/1	867.140	6x	-	27x2 FPM + 24x2,5 FPM	incl. 475.290	-	-
50	279.590	1x	1643 076	-	Set/kit	-	-
54	251.230	1x	1643 075	-	Set/kit	-	-
55	261.390	1x	1907 399	EWP/soft material	-	-	-
61	-	2x	1603 978	EPDM		-	-
62	-	1x	1603 977	FPM		-	-
70	908.570	1x	1899 998	-	-	-	-
80		16x	1958 374	23 ±2 Nm		-	-
80/1		17x	1971 745	-	 	-	-
80/2		2x	1951 065	-	 	-	-
80/3		14x	1951 064	-	 	-	-

The gasket kits are developed to meet the requirements for the professional engine repair.

MX 13 – EPA 10

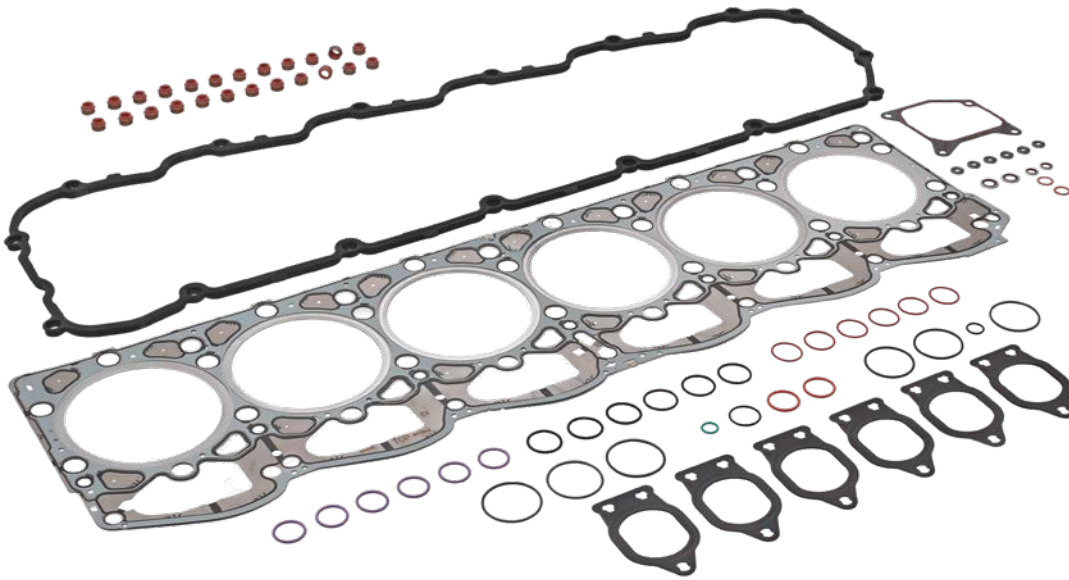

 478.880

Head gasket kit

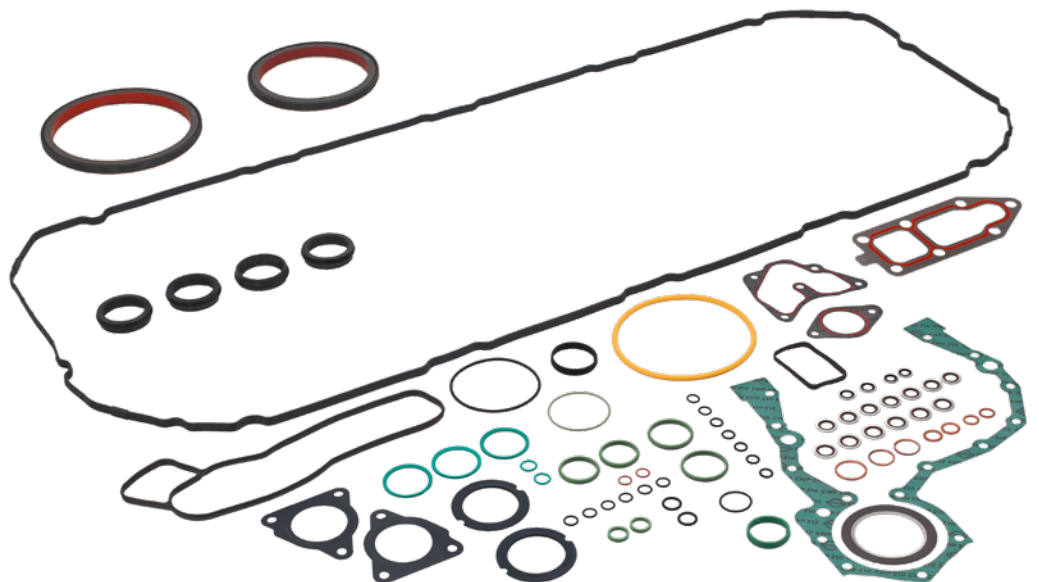

 478.890

Lower gasket kit

Valve cover gaskets

High temperature resistant elastomers are used for long lasting durability!



 : 246.160

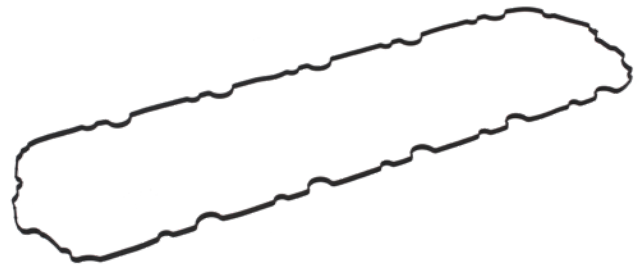

 : 440.220

Applicable for valve cover made out of plastic.
Fitting position: top



 : 440.230

Applicable for valve cover made out of plastic.
Fitting position: lower



www.elring.com
service@elring.com

ElringKlinger Automotive Manufacturing, Inc (Plymouth)
47912 Halyard Drive, Suite 111
Plymouth, MI 48170
USA

C510224 0421 USA

