

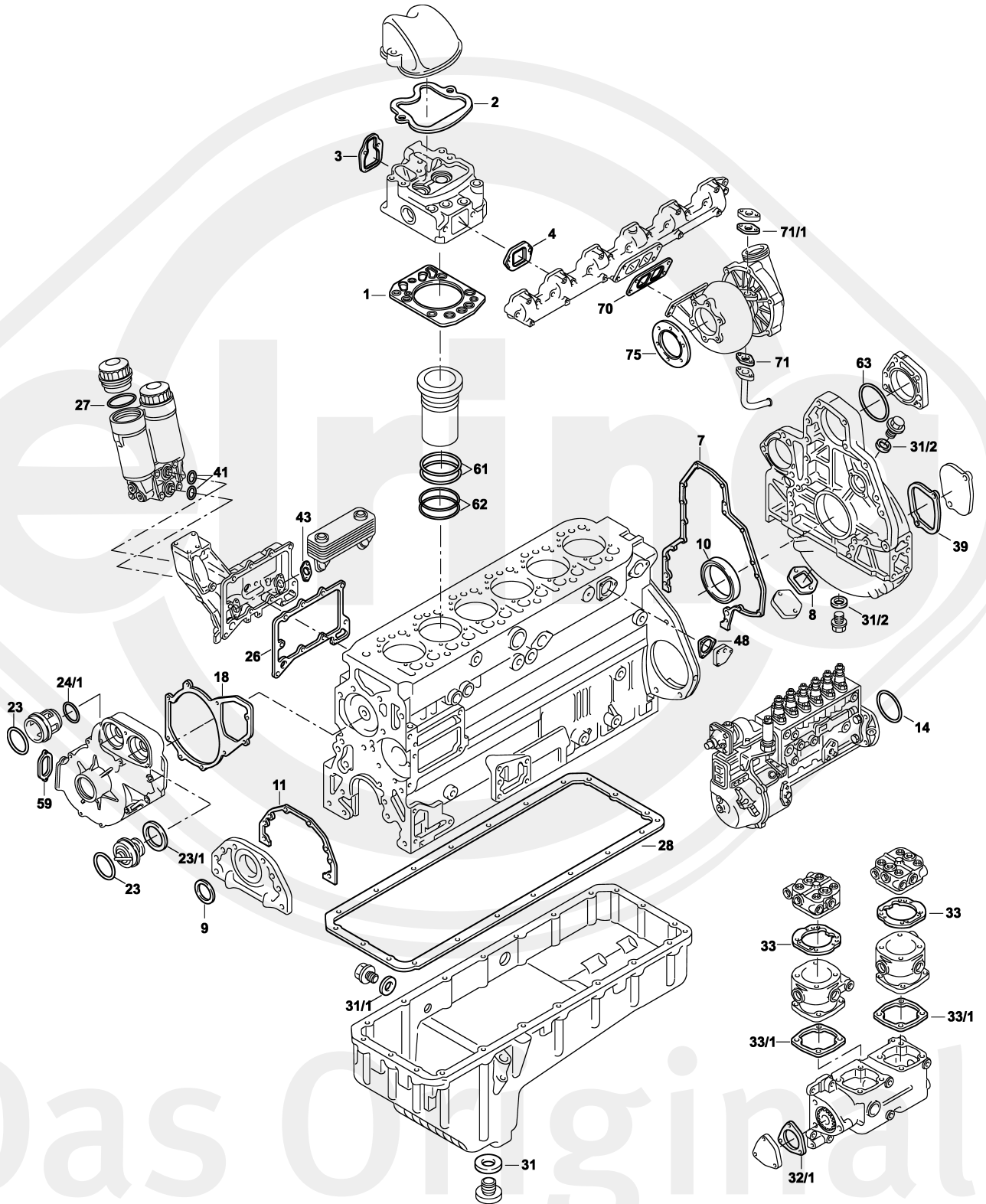

Das Original

MAN

D 2866 | D 2876









Das Original

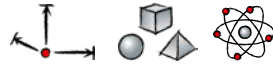

D 2866 LF 01-03 | 06 | 08-10 | 14 | 17 | 20-25 | 29-31 | 34 | 35 | 38-40 | 45

D 2876 LF 01 | 02









S *	518.340	1x	51.00900-6398	–	D 2866 LF LFG
ES	834.327	6x	51.00900-6558	–	 451.690
ES	834.330	6x	51.00900-6558	–	 829.722
ES	215.230	6x	51.00900-6629	–	 752.037
CS *	146.341	1x	51.00900-6602	–	D 2866 LF 01-03/06/08-10/14/17/ 20-25/29-31/34/35/38-40/45 LOH 01/20-26/30-31
CS *	146.351	1x	51.00900-6603	–	D 2866 LOH 02/03/06/07/09
ZLBS	542.340	6x	–	–	D 2866 LF LFG LOH
ZKS	820.548	6x	51.90490-6000	M15x2x109/144/168	–
TLS	716.090	1x	–	–	D 2866 LF LFG LOH
1	451.690	6x	51.03901-0356	Ø 144 mm	–
1	752.037	6x	51.03901-0298	Ø 144,5 mm	–
1	829.722	6x	51.03901-0338	Ø 144 mm, ME-Insert	–
2	638.901	6x	51.03905-0134	EWP/soft material	–
2	829.803	6x	51.03905-0135	Metal-soft material	–
2	946.300	6x	51.03905-0165	Metaloseal	–
2/1	816.340	2x	06.03223-0608	M8x35	946.300 Metaloseal
3	896.365	6x	51.08902-0161	–	–
4	638.951	6x	51.08901-0023	–	–
5	562.298	6x	51.04902-0028	12x15,7/20x15 FPM	–
7	829.595	1x	51.01903-0252	–	–
8	705.708	1x	04.10394-9292	70 ml	 Dirko™ HT 
9	766.853	1x	51.01510-6004	105x130x12 AW/BS RD PTFE/ACM	–
10	766.829	1x	51.01510-0206	120x140x13 AW/BS LD PTFE/ACM	–
11	834.556	1x	51.01903-0251	–	–
14	106.607	1x	51.96501-0346	138x3,5 FPM RD	–
18	756.882	1x	51.06901-0156	–	–
23	088.872	1x	06.56341-2122	60x4,2 EPDM RD	–
23/1	977.447	1x	51.06901-0108	–	–
24	088.872	1x	06.56341-2122	60x4,2 EPDM RD	–
24/1	095.842	1x	51.96501-0337	36,5x3,5 NBR RD	–
26	829.589	1x	51.05901-0119	EWP/soft material	–

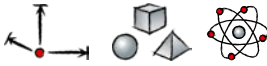

D 2866 LF 01-03 | 06 | 08-10 | 14 | 17 | 20-25 | 29-31 | 34 | 35 | 38-40 | 45

D 2876 LF 01 | 02

					
27	147.760	2x	06.56933-6408	91x4 ACM RD	-
28	845.541	1x	51.05904-0198	Elastomer/Rubber/Caoutchouc/ Goma	
28	921.084	1x	51.05904-0132	EWP/soft material	
31	153.260	1x	06.56631-0110	22,7x30x2 FE/FPM A	-
31/1	115.100	1x	06.56190-0706	14x20x1,5 CU A	-
31/2	115.100	1x	06.56190-0706	14x20x1,5 CU A	-
32/1		1x	51.08902-0151	-	-
33	775.790	2x	51.54901-0027	-	-
33/1	756.220	2x	51.54901-0028	EWP/soft material	-
33/1	374.690	2x	51.54901-0034	Metaloseal	-
35	106.909	6x	51.98701-0065	9,5x20x1 CU A	-
37	108.790	6x	51.96501-0348	6,2x11x1 CU PR	-
41	804.110	2x	06.56939-0027	31,42x2,62 FPM RD	-
43	759.296	2x	06.56254-2203	-	-
59	768.392	1x	51.06901-0183	EWP/soft material	-
61	803.881	12x	51.96501-0745	138x2,1 FPM RD	-
62	863.631	12x	51.96501-0746	144x4 FPM RD	-
63	244.848	1x	51.96501-0324	126x3 FPM RD	-
70	321.541	1x	51.08901-0150	-	-
71	804.580	1x	51.96601-0575	-	-
71/1	803.970	1x	51.96601-0577	-	-
75	830.748	1x	51.15901-0012	Metal-soft material	-
75	314.812	1x	51.08901-0096	Metaloseal	-