

Detroit Diesel DD15[®]

Mercedes-Benz OM 472



Website



Facebook



YouTube



Das Original



As an automotive supplier, ElringKlinger has become a trusted partner to its customers – with a firm commitment to shaping the future of mobility. These efforts are supported by a dedicated workforce of more than 10,000 employees at 45 ElringKlinger Group locations around the globe.

One highlight, amongst others showcasing this statement, are the cylinder-head gaskets for the latest Detroit Diesel engine family. Namely DD13, DD15 and DD16, with the 14,8l engine being the most popular one.

Those gaskets are supplied to the independent aftermarket by the internationally renown brand Elring – Das Original. The cylinder-head gaskets are designed as metal elastomer gasket, meaning the sealing of engine oil and coolant is done via injection molded elements directly on the metal carrier. This giving more strength in the harsh operating conditions. Sealing of the combustion chambers are executed with a bead on the carrier plates and an additional stainless steel fire ring to withstand the high compression ratio of 18,5 : 1.

Due to the overall length of the gaskets, ElringKlinger had to invent a design which can be best described as a puzzle and which is unique to the gasket industry. Eight different gasket elements are combined by only four rivets to form the final gasket. The result is a B 50 life of 1.2 million miles for the DD15 and DD16 engines and 1.0 million miles for the DD13. Customers and workshops should be aware of the fact that the cylinder-head gaskets come in different executions for EPA 7 and EPA 10.

Besides the cylinder-head gaskets, Elring also offers gasket kits and individual gaskets such as intake or exhaust gaskets, valve cover and oil pan gaskets. Details can be found on www.elring.com where exploded view drawings are available for download and easy part look up.

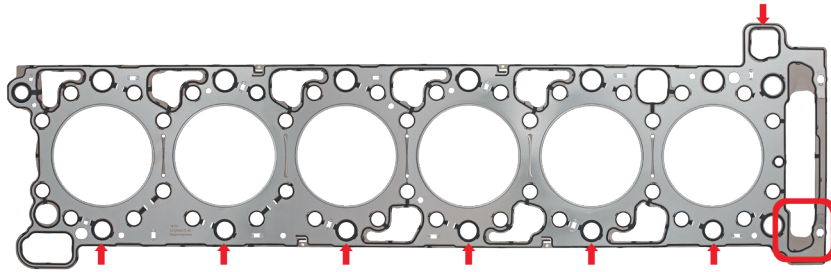

: 396.472

Engine: OM472.900, OM472.901, OM472.902

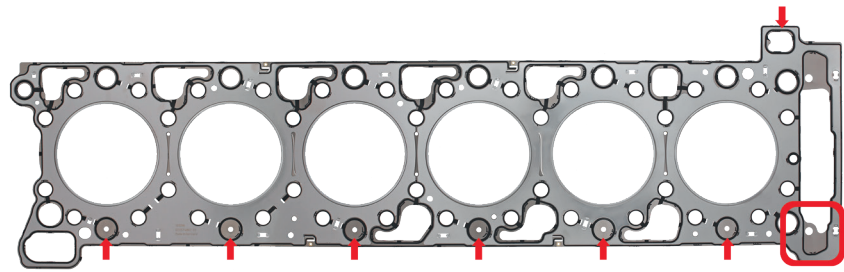

: 574.862

Engine: OM472.903, OM472.904, OM472.907

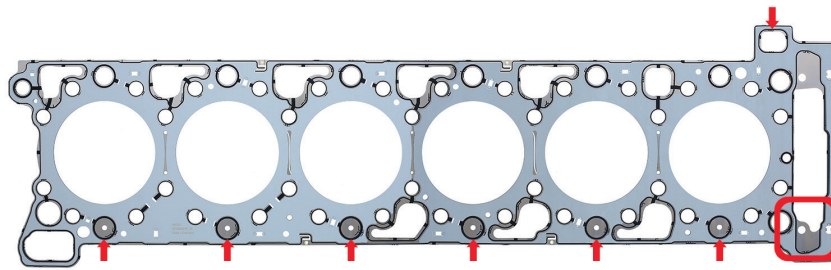

: 896.235

Engine: OM472.906, OM472.908, OM472.909, OM472.910



			#			
	934.240	1x	-	-	-	
	908.330	1x	-	-	-	
	911.960	1x	-	-	-	
	907.980	1x	-	M16 x 2 x 191	Kit	
	580.580	1x	-	-	Kit	
SZ	972.680	1x	-	-	Kit for waste gas turbine	
	654.270	1x	470 053 01 58	-	Kit	
1	396.472	1x	472 016 13 20	Ø 140 mm	-	
1	574.862	1x	472 016 14 20	Ø 140 mm	-	
1	896.235	1x	472 016 18 20	Ø 143,6 mm	-	
2	655.781	1x	472 016 06 80	-	-	
2	237.690	1x	472 016 07 80	-	-	
2/1	571.300	1x	472 016 01 21	-	-	
2/1	496.150	1x	472 016 01 80	-	-	
3	906.690	6x	472 098 00 80	-	-	
4/1	822.630	1x	472 142 18 80	-	-	
4/2	822.640	1x	472 142 19 80	-	-	
5	906.760	24x	470 053 01 58	9x13,4/16,1x15,2	-	
7	-	1x	472 015 03 80	-	-	
9	369.901	1x	016 997 06 46 015 997 97 46	100x130x11 ASW RD PTFE/ACM	-	
10	003.770	1x	015 997 49 46	138x163x12 AW/BS LD PTFE/ACM	-	
11	364.457	1x	472 011 02 80	-	-	
14	002.920	1x	017 997 89 45	100x3,1 FPM RD	-	
14/1	588.210	1x	000 091 08 60	-	-	
17	003.010	1x	017 997 74 45	123,8x3,5 FPM RD	-	
17	339.530	1x	022 997 31 45	121,35x4,5 FPM RD	-	

			#			
17/1	002.970	1x	017 997 94 45	114,2x2,58 FPM RD	-	
17/1	339.530	1x	024 997 52 45	121,35x4,5 FPM RD	-	
17/1	653.980	1x	026 997 71 45	110,7x3,1 FMVQ RD	-	
17/2	340.330	1x	470 090 05 79	-	-	
17/3	339.590	1x	021 997 33 45	62,75x3 FPM RD	-	
19	004.010	1x	472 201 00 80	-	-	
23	004.030	1x	472 203 00 80	-	-	
27	744.970	1x	014 997 87 45	128x4 ACM RD	-	
28	392.071	1x	472 014 03 22	AEM	-	
28	887.920	1x	473 014 01 22	ACM	-	
28	927.190	1x	472 014 00 22	FE/ACM	-	
29	003.050	2x	472 187 09 80	38,3x48x6,22 FPM	-	
29/1	897.241	1x	472 188 14 80	-	-	
29/1	566.180	1x	472 188 01 80	-	-	
29/2	003.040	2x	472 187 08 80	48,3x58x6,2 AEM	-	
29/3	003.050	2x	472 187 09 80	38,3x48x6,2 FPM	-	
29/4	566.180	1x	472 188 01 80	-	-	
31	-	1x	472 997 15 45	-	-	
31/1	805.050	1x	000000 001074	30x36x2 CU/ZNN A	-	
31/2		1x	472 018 03 80	-	-	
31/3	135.100	1x	007603 027100	27x32x2 CU A	-	
31/4		1x	472 018 03 80	-	-	
31/5	135.100	1x	007603 027100	27x32x2 CU A	-	
31/6	805.010	1x	000000 001071	18x24x1,5 CU/ZNN A	-	
31/6	805.020	1x	000000 001072	20x26x1,5 CU/ZNN A	-	
31/7	915.041	1x	014 997 41 48	10,5x2,7 NBR RD	-	
32	651.250	1x	023 997 71 45	125,2x3,1 FPM RD	-	
35	002.840	6x	017 997 88 45	29x3,5 FPM RD	-	
35/1	002.820	6x	017 997 87 45	29,4x2,65 FPM RD	-	
35/2	124.870	6x	906 017 02 60	7x15,1x1,5 CU	-	

Detroit Diesel DD15[®]

Mercedes-Benz OM 472

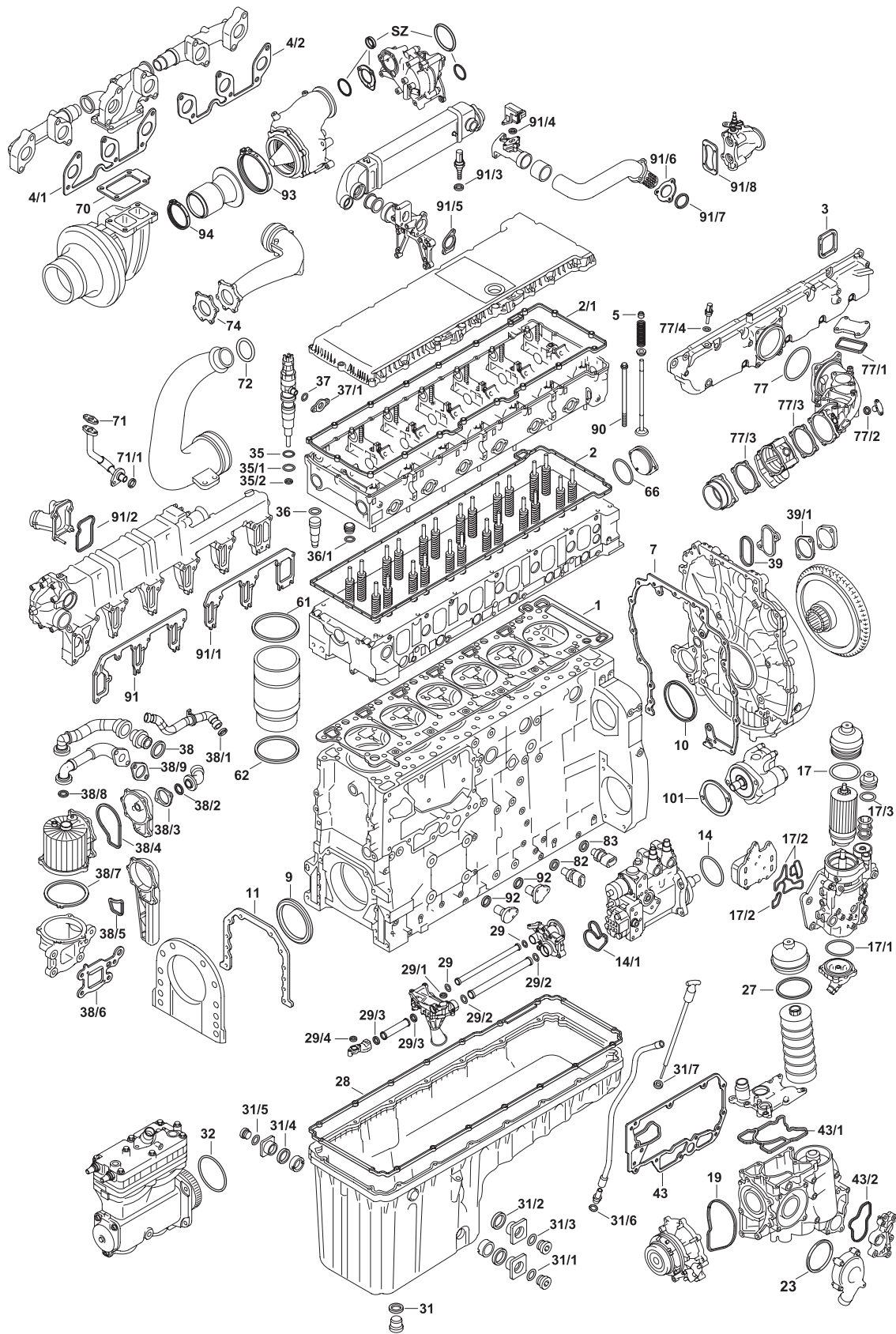



36	339.480	6x	024 997 64 45	34x2,5 FPM RD	-
36/1	074.870	6x	541 997 03 45	25x3,7 FPM RD	-
37	002.870	6x	017 997 86 45	13x2 FPM RD	-
37/1	002.880	6x	472 078 01 80		-
38	003.950	1x	457 997 06 45	36x2,5 NBR RD	-
38/1	003.950	1x	457 997 06 45	36x2,5 NBR RD	-
38/2	003.970	1x	472 997 20 45 472 997 24 45	24,2x3 FPM RD	-
38/3	387.520	1x	472 018 01 80	-	-
38/4	003.960	1x	472 998 00 06	-	-
38/5	444.980	1x	472 015 07 80	-	-
38/6	719.750	1x	472 018 07 80	-	-
38/7	004.000	1x	472 015 06 80 472 015 08 80	-	-
38/8	003.970	1x	472 997 23 45 472 997 24 45	24,2x3 FPM RD	-
38/9	387.520	1x	472 018 01 80	-	-
39	003.790	1x	472 015 02 80	-	-
39/1	478.360	1x	472 015 01 80	-	-
39/1	699.160	1x	000 236 18 80	-	-
43	003.100	1x	472 184 19 80	-	-
43/1	003.200	1x	472 184 00 80	-	-
43/2	003.690	1x	472 184 05 80	-	-
61	653.770	6x	024 997 48 45 022 997 52 45	155x162,4x3,9 FPM PX	-
62	653.760	6x	020 997 48 45 023 997 53 45	138,5x4,6 FPM PX	-
66	906.670	1x	472 997 08 45	89,2x4 ACM RD	-
70	865.090	1x	473 096 02 80 472 096 03 80	-	-
71	527.090	1x	541 187 00 80	-	-
71/1	003.730	1x	018 997 31 45	21,7x5 ACM RD	-



72	491.970	1x	025 997 43 48	58x3,5 FPM RD	-
74	656.330	1x	471 142 06 80	-	-
77	906.740	1x	472 098 01 80	-	-
77	445.270	1x	472 098 08 80	112x10 FPM RD	-
77/1		1x	460 098 03 80	-	-
77/2	303.620	1x	472 098 06 80	-	-
77/3	906.710	2x	460 098 01 80	-	-
77/3	-	1x	460 098 04 80	-	-
77/4	804.980	1x	000000 001069	14x20x1,5 CU/ZNN A	-
82	804.980	1x	000000 001069	14x20x1,5 CU/ZNN A	-
83	804.990	1x	000000 001070	16x22x1,5 CU/ZNN A	-
90	-	38x	472 016 01 69	M16x2x191	-
91	873.400	1x	472 203 08 80	-	-
91/1	873.410	1x	472 203 09 80	-	-
91/2		1x	472 203 01 80	-	-
91/3	804.980	1x	000000 001069	14x20x1,5 CU/ZNN A	-
91/4	-	1x	470 153 00 80	-	-
91/5	-	1x	472 142 08 80	-	-
91/6	559.220	1x	472 096 01 80	-	-
91/7	906.700	1x	472 997 02 45 472 997 09 45	68x4 FPM RD	-
91/8	593.880	1x	472 142 20 80	-	-
92	816.957	4x	022 997 25 48	17x1,8 FPM RD	-
93		1x	000 995 82 02 002 995 15 02	-	-
94		1x	000 995 81 02 001 995 41 02	-	-

The gasket kits are developed to meet the requirements for the professional engine repair.

They are equipped with all necessary gaskets and seals revealing the expertise of 140 years in engine gasket business.

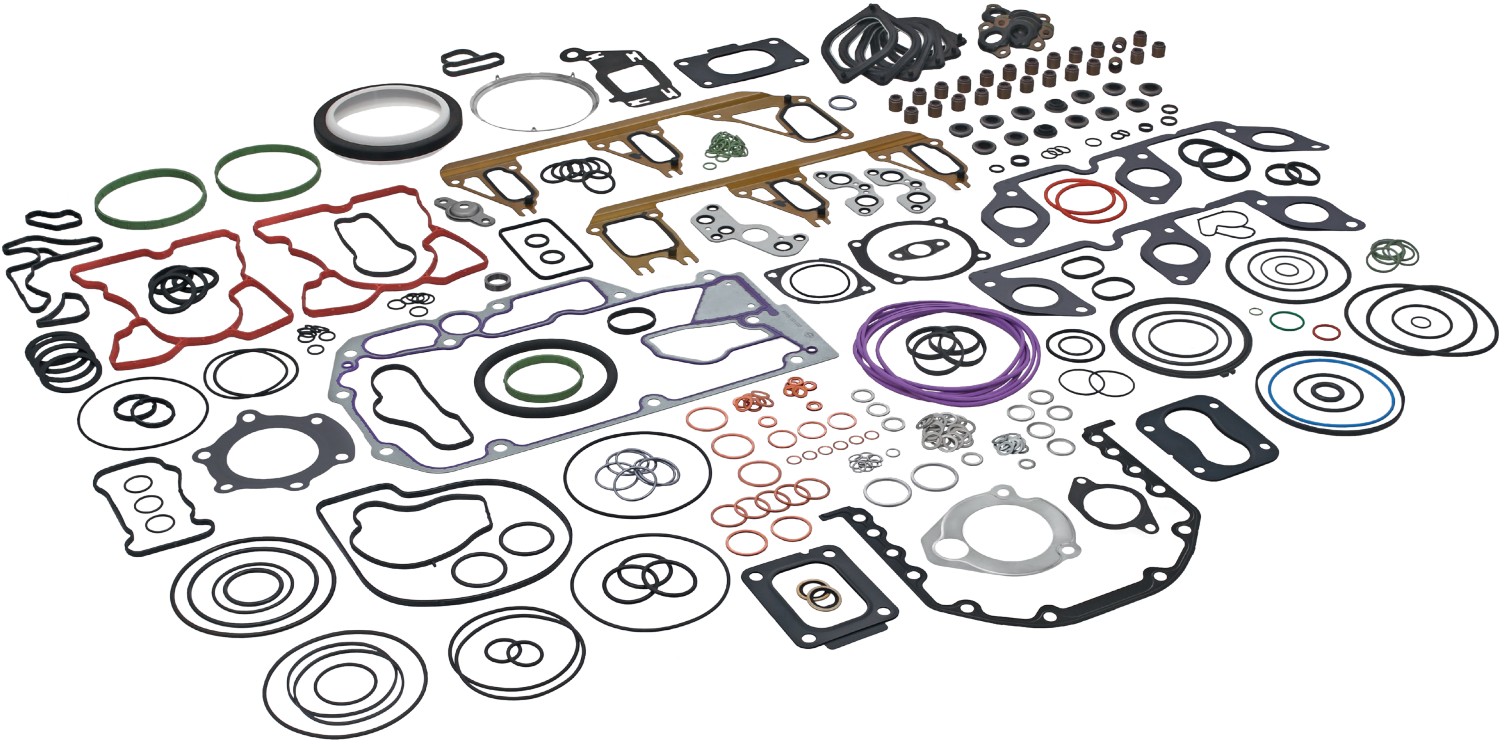

 934.240
Full gasket kit

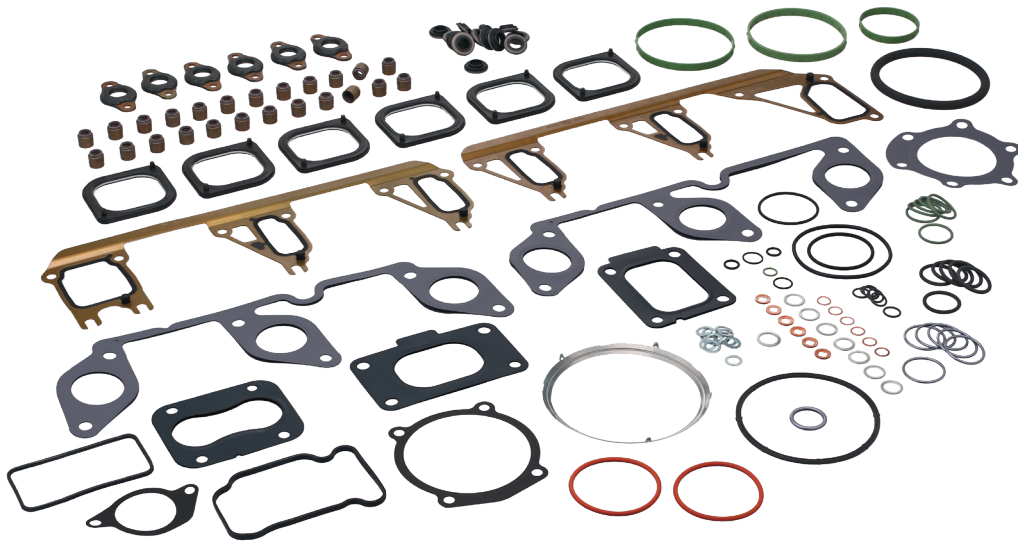

 : 908.330
Head gasket kit

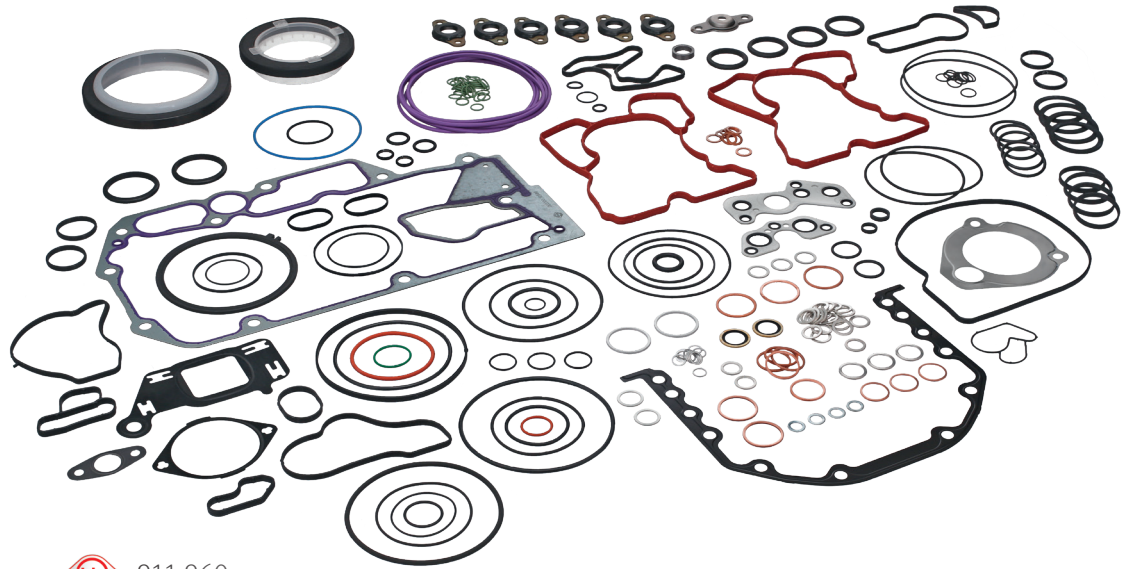

 : 911.960
Lower gasket kit

Valve cover gaskets

High temperature resistant elastomers are used for long lasting durability!

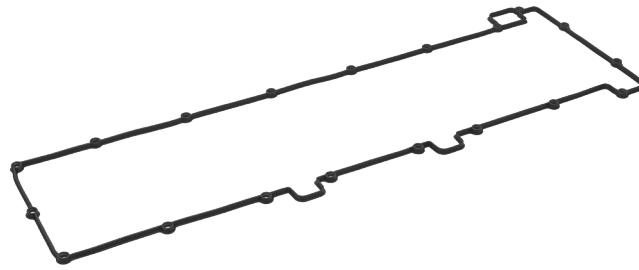

 : 496.150

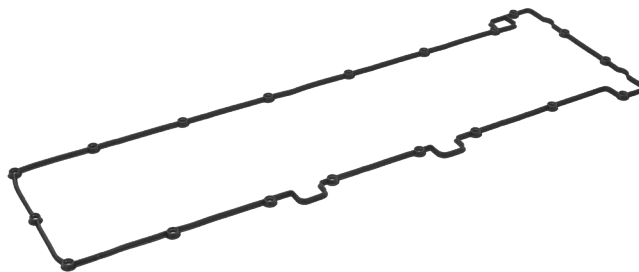

 : 571.300

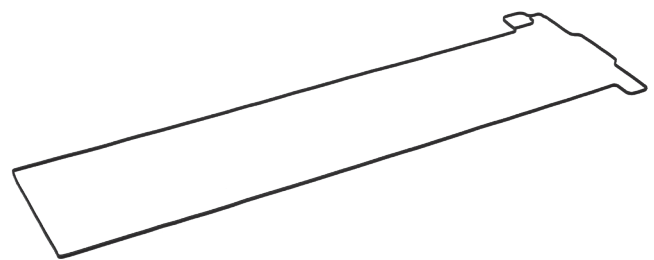

 : 237.690

Camshaft housing gasket

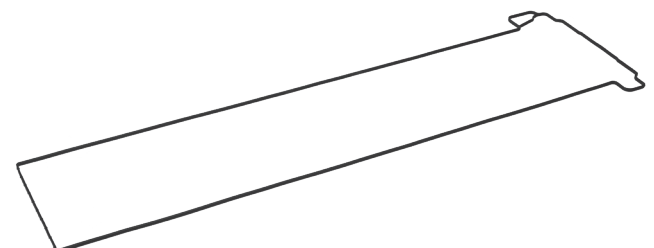



 : 655.781

Camshaft housing gasket

Oil pan gaskets

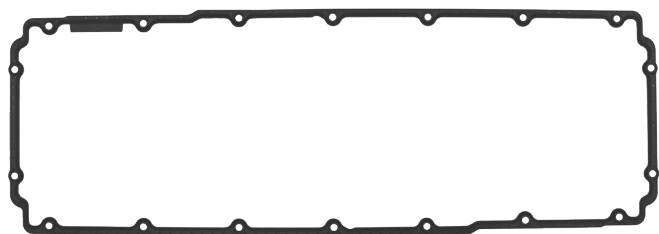
Depending on oil pan material, Elring also offers a version with inner metal frame!



 : 927.190

Metal-elastomer



 : 887.920

Elastomer

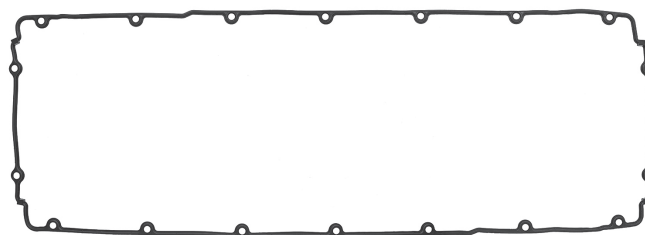

 : 392.071

Elastomer



www.elring.com
service@elring.com

ElringKlinger Automotive Manufacturing, Inc (Plymouth)
47912 Halyard Drive, Suite 111
Plymouth, MI 48170
USA

C510223 1219 USA



Das Original